



Panasonic®

Operating Instructions
(Household) Sonic Vibration Toothbrush
Model No. EW-DE92

Contents

Safety precautions	3	Frequently Asked Questions	
Parts identification	6	(Ion lamp)	14
Storing and charging the toothbrush		Troubleshooting	15
.....	7	Battery life	17
Before cleaning your teeth	8	Removing the built-in rechargeable	
Using the toothbrush	10	battery	17
Tips on usage	11	Specifications	17
How to clean	13	Changing the brush head	
		(Sold separately)	18

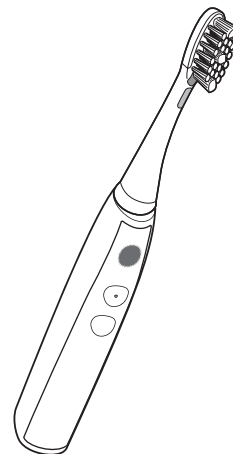

Thank you for purchasing this Panasonic product.
Before operating this unit, please read these instructions completely and save them for future use.

IMPORTANT SAFEGUARDS

When using electrical products when children are present, basic safety precautions should always be followed including the following:

READ ALL INSTRUCTIONS BEFORE USING

DANGER

In order to reduce the risk of electrocution:

1. Do not place or store the charger where it can fall or be pulled into a tub or sink.
2. Do not place the charger in water or other liquid.
3. Do not reach for a charger that has fallen into water. Unplug immediately.
4. Do not wash the charger.
5. Do not use while bathing.

WARNING

To reduce the risk of burns, electrocution, fire or injury to persons:

1. This appliance is not intended for use by children or persons with reduced physical or mental capabilities, unless they are supervised by a person responsible for their safety.
2. Use this product only for its intended use as described in this manual. Do not use attachments not recommended by the manufacturer.
3. Keep cord away from heated surfaces.

4. Never drop the appliance or insert any object into any opening of the appliance.
5. Never operate this product if it has been dropped or damaged, or if it is not working properly. If any of these occur, please contact a service center and return the product for examination and repair.
6. If the product is dropped, the brush head should be replaced before the next use even if no damage is visible.
7. This appliance is provided with a charger with integrated Safety Extra Low Voltage power supply. Periodically check the charger for damage. A damaged or non-functioning appliance should no longer be used. Take it to a service center.
8. Never use while drowsy.
9. Do not use outdoors or operate where aerosol (spray) products are being used or where oxygen is being administered.

IMPORTANT

1. Do not touch the power plug with wet hands. This can cause an electric shock.
2. When unplugging, always hold the power plug instead of the cord.

3. Do not modify the product. Do not disassemble or repair. This may cause fire, electric shock or injury. Consult your dealer for repairs or contact a service center. Do not disassemble the product except when disposing of the battery.
4. When taking out the battery for disposal, use caution not to short the positive (+) and negative (-) terminals.
5. This product is not intended for use by children.

CAUTION

If you are undergoing treatment for any oral care condition, consult your dental professional prior to use.

SAVE THESE INSTRUCTIONS

Safety precautions

To reduce the risk of injury, loss of life, electric shock, fire, malfunction, and damage to equipment or property, always observe the following safety precautions.

Explanation of symbols

The following symbols are used to classify and describe the level of hazard, injury, and property damage caused when the denotation is disregarded and improper use is performed.



DANGER

Denotes a potential hazard that will result in serious injury or death.



WARNING

Denotes a potential hazard that could result in serious injury or death.



CAUTION

Denotes a hazard that could result in minor injury.

The following symbols are used to classify and describe the type of instructions to be observed.



This symbol is used to alert users to a specific operating procedure that must not be performed.



This symbol is used to alert users to a specific operating procedure that must be followed in order to operate the unit safely.

DANGER

To prevent the potential risk of interference, do not use this toothbrush near the vicinity of electronic medical devices or home electrical therapy devices such as the following:

-  Pacemakers and other electronic medical devices implanted in the body
- Heart-lung machines and other life-supporting electronic medical devices
- Wearable electronic medical devices, such as electrocardiographs and intravenous drip equipment

 This product has a built-in rechargeable battery. To prevent the risk of overheating, ignition or explosion, do not throw into fire, apply heat, or charge, use, or leave in a high temperature environment.

WARNING

To prevent the risk of personal injury, electric shock or fire, immediately stop use and unplug the charger from the wall outlet if you observe some abnormality in the product. Have the product inspected by an authorized service center if the toothbrush or charger is deformed or abnormally hot, there is smell of burning or abnormal sound.

 To prevent the risk of electric shock or fire, fully insert the power plug.

 To prevent the risk of fire due to insulation failure by humidity, clean the power plug once every six months. Disconnect the power plug and wipe dust off with a dry cloth.

 To prevent the risk of accident or injury due to accidental ingestion of removable parts, do not store within the reach of children or infants. Do not let them use it.

 This toothbrush releases minute amount of weak current. To prevent accidents or cause them to feel unwell, do not use during pregnancy and within one month after giving birth.

 To prevent risk of electric shock or fire, do not damage, modify, forcefully bend, pull, twist, or bundle cord. Do not wrap the cord around the charger when storing.

 To prevent the risk of burns or fire, use the supplied charger only and do not charge any other product with the supplied charger.

CAUTION

 To prevent the risk of injury or damage to teeth and gum, do not use this toothbrush if you have severe gum disease, have teeth being treated, or are concerned about symptoms in your mouth. Consult a dentist before using this toothbrush.



CAUTION



To prevent the risk of injury or damage to teeth and gum, do not use toothpaste that contains a high abrasive content, such as toothpaste for removing tar or for whitening. Do not apply the brush head strongly against teeth or gums, or use it continuously on same spot. Do not apply the plastic part of the main unit or brush head to teeth.



To prevent risk of burns, do not place a metallic object such as a coin or a clip on top of the charger.

► Notes

When you first begin using the toothbrush, you may experience slight bleeding of the gums even though your gums may be healthy. This is because your gums are receiving stimulation by the toothbrush for the first time. The bleeding should stop after one or two weeks of use. Bleeding that persists for more than two weeks may be indication of an abnormal condition of your gums, such as pyorrhea. In this case, stop using the toothbrush and consult your dentist.

Parts identification

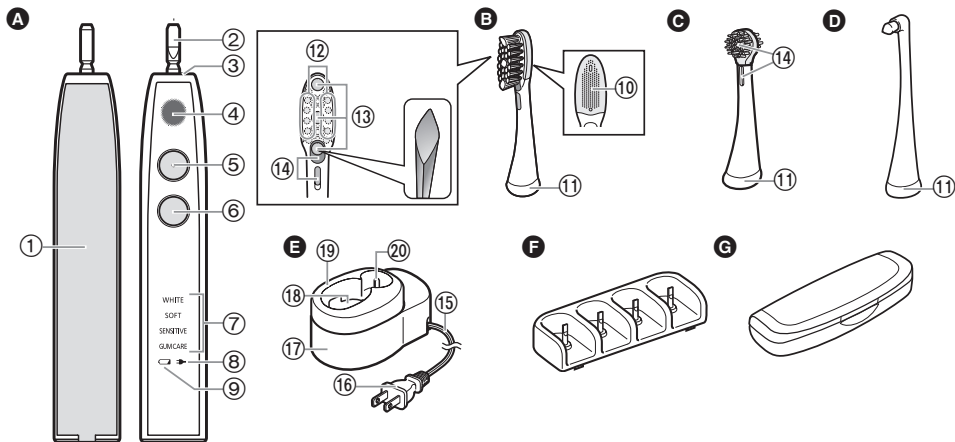

A Main unit

- ① Ion panel
- ② Toothbrush shaft
- ③ Waterproof rubber seal
- ④ Ion lamp
- ⑤ Power switch [0/1]
- ⑥ Mode selector
- ⑦ Mode indicator
- ⑧ Charge status lamp (→)
- ⑨ Battery capacity lamp (↔)

B Ionic stain care brush

- ⑩ Tongue cleaner
- ⑪ Identification ring
- ⑫ Extra fine side bristles
- ⑬ High-density bristles
- ⑭ Brush head electrode section

C Ionic two-way silicone brush

D Point brush

E Charger (RE8-52)

- ⑮ Cord
- ⑯ Power plug
- ⑰ Charger base
- ⑱ Charging section
- ⑲ Main unit guide
- ⑳ Brush head storage

Accessories

F Brush stand

G Travel case

Characteristics of brush bristles (⑬)

The bristles in the center (high-density bristles) are arranged in a diamond shape, which is designed for stain care.

Storing and charging the toothbrush

- If the toothbrush stops operating when first using it (immediately after purchasing it, or after not using it for 3 months or more) or during use, charge the main unit.
- Adequate ambient temperature for charging is 5 °C – 35 °C (41 °F – 95 °F).
The battery may not charge properly or not at all under extreme low or high temperatures.
- You can keep the main unit attached on the charger when not in use to maintain the full battery capacity. It will not overcharge the main unit.
- The main unit may become warm during use and charging. However, this is normal.

1 Place the charger on a stable horizontal surface such as countertop.

2 Align the main unit so it is facing forward, and set it straight into the charging section.

3 Insert the power plug into the household outlet.

- The charge status lamp glows and the charging will start.
- Charging cannot start when the main unit is tilted or the bottom of the main unit is not in contact with the charging section.

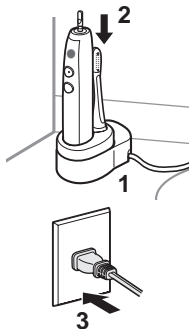

If not charging constantly

- You can fully charge the toothbrush in approx. 17 hours.
The charging time may decrease depending on the charging capacity.
- A full charge will supply enough power for approx. 90 minutes use.
- Disconnect the power plug when the charge status lamp turns off.

► About storage

Use the main unit guide to store the main unit and the brush head.

1. Slide and remove the main unit guide, and place it on horizontal and stable place.

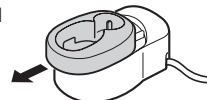

2. Store the main unit and the brush head.



About the lamp

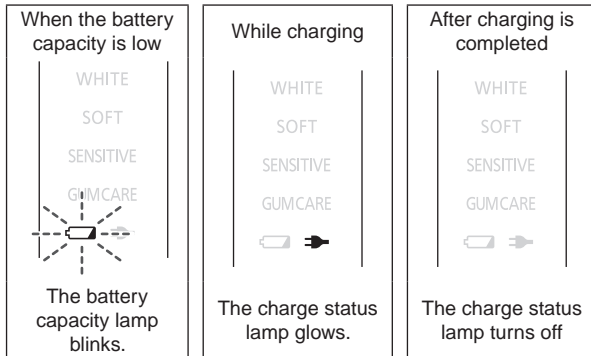

- The toothbrush may not charge even if the charge status lamp turns on when a charger other than the supplied charger is used.

Before cleaning your teeth

The brush head of this sonic vibration toothbrush vibrates at a high speed.

Therefore:

- You only need to lightly press the bristles against your teeth for brushing.
- When first using this appliance, some may experience a tickling or tingling sensation caused by the high-speed vibrations. The sensation should subside after you use the toothbrush several more times.
- When in use, the main unit of this toothbrush emits a very weak electric current (ionic current) in the oral cavity.
- Touching the ion panel with your hand when you hold the main unit to brush your teeth causes a very weak electric current (ionic current) to flow between your teeth and the brush head.

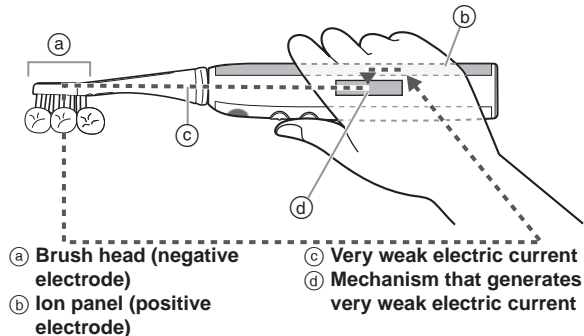

- The ion lamp on the mechanism that generates the very weak electric current (see figure above) turns on or blinks to indicate whether ionic power is being applied to the teeth.

- You can easily see the lamp status if you use a mirror while brushing.
- Ionic power is not employed with the point brush. (The ion lamp blinks.)

Pressing the power switch

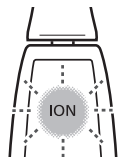

Activates the mechanism that generates the very weak electric current, and the ion lamp blinks on and off.

Putting the brush in your mouth

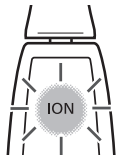



Passes a very weak electric current in the oral cavity, ionic power is activated and the ion lamp turns on.

Notes

- Recommended ambient temperature for using is 5 °C – 35 °C (41 °F – 95 °F).
- Do not allow hair products (e.g., gel or oil) or hand lotion to come in contact with the unit as they may damage its surface.
- Do not forcefully turn the brush head with the brush head attached to the main unit. Doing so may cause the brush head or main unit to become damaged.

► About uses and operating modes

Brush head	Use	Mode	Description
	Brushing (dental plaque removal)	WHITE	• Recommended for removing plaque and stain care with normal tooth brushing
		SOFT	• Recommended when you feel the WHITE mode is too powerful • Recommended for tongue cleaning
		SENSITIVE	• Recommended for brushing carefully between the teeth and gums
	Gum care	GUM CARE	• Uses rhythmical vibrations to care for your gums.
	Point brushing	WHITE	• Recommended for removing dental plaque from between teeth and areas where teeth are misaligned
		SOFT	• Recommended when you feel the WHITE mode is too powerful
		SENSITIVE	• Particularly recommended when brushing to care for areas between teeth

- Stains refer to discoloration on the surface of the teeth due to food and drink such as coffee, wine and tea.

- It is not possible to whiten the color of teeth beyond their original color, yellowing teeth due to aging, or discolored teeth.

► **About soft start function (For WHITE mode only)**

The toothbrush will gradually reach the selected speed and vibration approximately 2 seconds after it starts operating.

► **About the 30-second brushing notification timer function**

The timer will signal once at 30-second intervals to indicate the brushing time for each part of your mouth. It will signal twice at 2-minute intervals to indicate the recommended total brushing time. It is important to brush each area in the same sequence and with the same amount of time, every time you brush, to uniformly brush and clean your teeth.

Use the 30-second brushing notification timer function wisely so there will be no missed spot in your mouth.

- Divide your teeth into 4 parts (upper and lower, left and right), and brush one part in order such as "(1) front of the teeth", "(2) biting plane of the teeth", and "(3) back of the teeth" spending 30 seconds at each part. Brush the other parts in the same manner, and brush your whole mouth in about 2 minutes.

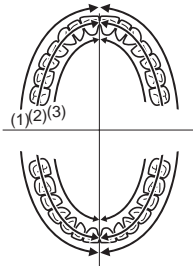

► **About mode storage function**

This function stores the previously selected mode of operation, allowing the same mode to be used again.

Mode storage is reset if the unit has discharged and has been unused for a long period of time, or if the battery has been completely drained.

After charging, the product starts in WHITE mode, however this is not a malfunction.

Using the toothbrush

- If dried toothpaste or water stains have adhered to the ion panel, the very weak electric current may be unable to pass into the oral cavity. Please clean the ion panel.

1 Place the brush head firmly onto the toothbrush shaft.

- As shown in the picture, align the front of the electrode section of the ionic stain care brush or silicone brush with the main unit.
- Attaching or removing diagonally or while twisting may cause the brush head or the main unit to become damaged.
- The toothbrush shaft will move when a force is applied. This is required for operation, and is not a malfunction.
- There will be a small gap between the brush head and the main unit.

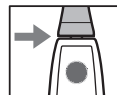
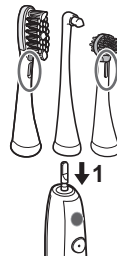

2 Grasp the main unit.

- The very weak electric current may not pass into the oral cavity if the toothbrush is held in the same way as a pen so that your hand does not touch the ion panel. Please grasp the main unit as shown in the figure, so that your hand comes in contact with the ion panel.

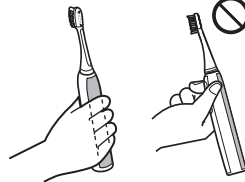

3 Press the mode selector to select the mode.

- The previously selected operating mode is stored, and the mode indicator turns on.
- Each time you press the mode selector, the mode changes.
(See page 9.)

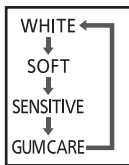
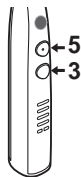

4 Place the toothbrush in your mouth.

- Apply a small amount of toothpaste to the brush head, if desired, before turning the power on to prevent the toothpaste from spattering.

5 Press the power switch to turn on the main unit.

- During operation, the operating mode changes each time the mode change switch is pressed.
- The sound may increase when the brush head is pressed too strongly against the teeth, but this is not a malfunction. Apply the brush head lightly against the teeth.

6 Turn off the main unit when you have finished brushing.

- Turn off the main unit before removing it from your mouth to prevent foam from spattering.

Tips on usage

How to apply/move when brushing your teeth

Mode: WHITE/SOFT/SENSITIVE

- **For the boundary between the tooth surfaces, or teeth and gums**
Place the bristles at a 45° angle.

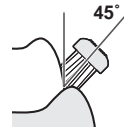

- **For the back of the front teeth or misaligned teeth**

Brush vertically.
Move toothbrush to match the angle of the teeth.



- **For the biting surface (back teeth)**

Apply from top.

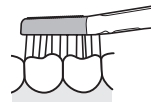

- Place the bristles of the brush gently against your teeth and move the toothbrush slowly.
The movement will slow down when the brush head is applied too strong.
- Apply a small amount when using toothpaste.

How to apply/move when cleaning your tongue

Mode: SOFT

Apply the tongue cleaner so that it barely touches the tongue, and move forward with slight force from the area that becomes dirty.

Repeat several times.

- You may injure your tongue if the tongue cleaner is pressed against the tongue too hard.

► To prevent emetic response

Poke your tongue out and apply the brush while you are breathing out.



How to use the point brush

Mode: WHITE/SOFT/SENSITIVE

Use in areas where your teeth are misaligned or in areas that are hard to reach with a standard brush head.

- Use the brush perpendicularly.
- Move the brush gently between your teeth.
- Apply just enough strength so that the tips of the brush head bristles are lightly touching your teeth.

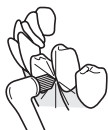

How to use the ionic two-way silicone brush

Mode: GUM CARE

- Carbon is used in the rubber section, so gripping it firmly may cause a black powder to adhere to your hands, however this is not a safety concern.
- This toothbrush is different to one with a brush head with nylon bristles, as there is no sense of scouring-type brushing.
- Be careful when using the brush head - forcefully pulling or biting the rubber section may cause it to come off.
- Do not apply the brush to your teeth. (This can cause the silicone brush to degrade.)
- Select your preferred stiffness from "normal" or "stiff."

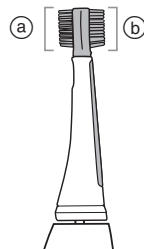

- (a) "Normal" stiffness
- (b) "Stiff" stiffness

► Application to gums/movement

- Use as close as possible to a right angle.
- Use the toothbrush so that the tips of the silicone brush bristles are lightly touching your gums. Move the brush back and forth gently across your entire gums.
- Recommended usage is once a day, for approximately 2 minutes.
- Use gently at points of concern. (Use for around 10 to 20 seconds at each area.)

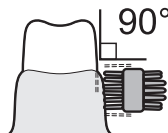

How to clean

Use mild detergent when cleaning the product with detergent. Never use chemical agents such as thinner, benzene, or alcohol.

Cleaning the main unit and the brush head

- Cleaning and user maintenance should not be made by children.
- Turn off the main unit and remove the brush head before cleaning them with water.

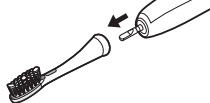

► Brush head

Wash the brush head under running water.

- Carefully wash the inside and the bottom areas of the brush head, as well as the brush head electrode section.
- Shake well to remove water after washing.
- Do not pull the bristles of the brush.
- Do not force apart the rubber section of the silicone brush.
- Do not wash with water hotter than 80 °C (176 °F).
- Do not wash the tongue cleaner excessively with a pointed object or fingernails.



► Main unit

Wash the main unit under running water.

- Do not rub or damage the waterproof rubber seal.
- Do not immerse the main unit under water.
- Do not wash with water hotter than 40 °C (104 °F).
- Completely remove any toothpaste or water stains from the ion panel.

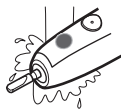

► After washing with water

1. Wipe dry with a cloth.
 - Do not charge while it is wet.
2. Return the main unit and the brush head to the charger.
 - Return other brush heads to the brush stand.

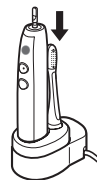

If the identification ring comes off

Put the identification ring back on.

- The identification ring may break if pulling it too strong.
- Using the toothbrush without the identification ring has no effect on its performance. The ring is simply for user identification purposes.

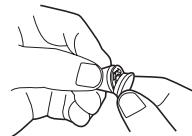

Cleaning the charger

1. Slide and remove the main unit guide from the charger base.
2. Wipe off any dirt on the charger base using a soft cloth.

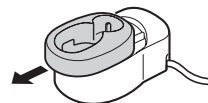

- Wash the main unit guide with water.
 - Wipe off water after washing.
 - Only use water to wash the main unit guide.
- Wipe the prongs of the power plug with a dry cloth about once every 6 months.



Cleaning the travel case and the brush stand

- Wash with water.

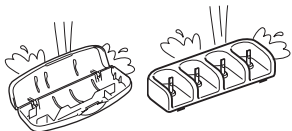

- Wipe off water after washing.

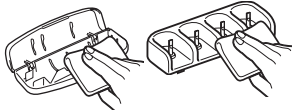

If the top case has come off

- Align the mounting section of the top case and the bottom case as shown in the figure.
- Press the top case in the direction indicated by arrows.

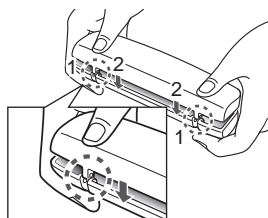

Frequently Asked Questions (Ion lamp)

Q	The lamp does not turn on, even though the toothbrush is in my mouth.	
A	Your hands are dry.	▶ Moisten your hands and try using it again.
	Toothpaste or water stains have adhered to the ion panel.	▶ Clean the ion panel thoroughly and try using it again.
	You are brushing without touching the ion panel.	▶ Hold the main unit so that your hand is touching the ion panel and try using it again.
Q	The lamp turns on even though the toothbrush is not in my mouth. (This is not a malfunction.)	
A	During use, you may have touched the ion electrode section of the ion panel and brush head (or the toothbrush shaft) with your hand.	▶ The very weak electric current may be flowing through the moisture that is on your hands.
	You washed the main unit with water while using it.	▶ The very weak electric current may be flowing through the moisture between the toothbrush shaft and the ion panel.
	You removed the brush head from your mouth just after brushing without turning off the power switch.	▶ The very weak electric current may be flowing through saliva or other liquid on the surface of the brush head and main unit.

Troubleshooting

Problem	Possible cause	Action
The charge status lamp does not turn on.	▶ You have just purchased the toothbrush or have not used it for a while.	▶ The toothbrush may not blink or turn on for several minutes after starting to charge it, however it will turn on if you continue to charge it. If it continues to blink after a while, contact an authorized service center for repair.
The charge status lamp is blinking rapidly. (Twice every second)	▶ The temperature is too low or high while charging.	▶ Charge the toothbrush within the recommended charging temperature of 5 °C (41 °F) to 35 °C (95 °F). If it continues to blink even when charging within the recommended charging temperature, contact an authorized service center for repair.
The toothbrush can be used only for several minutes, even if it is charged.	▶ The charging time is short. ▶ The main unit does not stand straight on the charger.	▶ Charge the toothbrush for 17 hours or longer. (See page 7.) ▶ Stand the main unit so the bottom is in contact with the charging section of the charger, and check that the charge status lamp comes on.
The toothbrush does not operate without the battery capacity lamp blinks.	▶ The rechargeable battery has reached its operating life. (Approx. 3 years)	▶ Contact an authorized service center for repair.
The toothbrush does not operate.	▶ The temperature is too low or high while using it.	▶ Use within the recommended usage temperature of 5 °C (41 °F) to 35 °C (95 °F).
The toothbrush stops operating every once in a while.	▶ The “30-second brushing notification timer function” is in operation. (See page 10.)	▶ This is not a malfunction. Continue using it.
The vibration increases gradually when pressing the power switch.	▶ The “Soft start function” is in operation. (See page 10.)	

Battery life

Approximately 3 years. The battery may have reached its operating life if the usage frequency decreases drastically, even after a full charge.

(The operating life of the battery may differ depending on usage or storage conditions)

Removing the built-in rechargeable battery

ATTENTION:

A lithium ion battery that is recyclable powers the product you have purchased. Please call 1-800-8-BATTERY for information on how to recycle this battery.



Remove the built-in rechargeable battery before disposing the toothbrush.

This figure must only be used when disposing the toothbrush, and must not be used to repair it. If you dismantle the toothbrush yourself, it will no longer be waterproof, which may cause it to malfunction.

- Remove the toothbrush from the charger when removing the battery.
- Press the power switch to turn on the power and then keep the power on until the battery is completely discharged.
- Perform steps ① to ④ and lift the battery, and then remove it.
- Please take care not to short-circuit the battery.

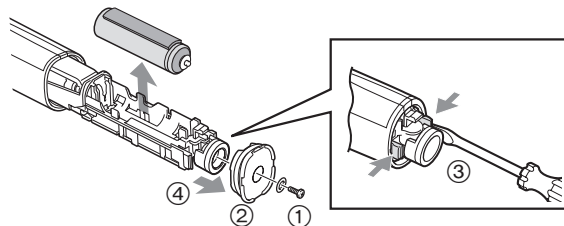





Specifications

Power source	See the name plate on the product (Automatic voltage conversion)
Battery	1 Lithium-ion battery (3.6 V; 500 mAh)
Charging time	Approx. 17 hours

This product is intended for household use only.

Changing the brush head (Sold separately)

- The brush should be replaced with a new one every 3 months or so due to hygiene reasons, even if its shape is unchanged.
- If the bristles are bent to one side or worn, the toothbrush is not effective for brushing. Replace the brush head with a new one.

Part number	Replacement Brush for EW-DE92	
WEW0908	Ionic stain care brush	
WEW0906	Ionic two-way silicone brush	
WEW0940	Point brush	
WEW0929	Stain care brush	

Personal Care & Beauty Care Products

FOR USA AND PUERTO RICO ONLY

30-Day Quality Satisfaction Guarantee

If you are dissatisfied with any Panasonic Personal Care & Beauty Care Products for any reason, simply return it to the place of purchase with a dated proof of purchase, in the original packaging, with all accessories, parts and instructions, within 30 days of the date of purchase, for a full refund, or call Panasonic at 1-800-338-0552.

Abuse or misapplication of this product voids the guarantee.

**FOR YOUR CONVENIENCE, WE HAVE ESTABLISHED A
TOLL-FREE (IN USA ONLY) NATIONAL ACCESSORY
PURCHASE HOT LINE AT 1-800-332-5368.**

MEMO

IN USA CONTACT:

Panasonic Corporation of North America
Two Riverfront Plaza, Newark, NJ 07102-5490

Service • Assistance • Accessories

Call 1-800-338-0552 (In USA)

<http://www.panasonic.com/consumersupport/>

Panasonic Corporation

33, Okamachi, Hikone, Shiga, Japan

Panasonic Corporation

<http://panasonic.net/>

© Panasonic Corporation 2013